

Multiquip MQB-190A and MQB-190B 90 lb Paving Breaker
Tools Renewed 800-247-3639 Fax: 860-665-9821 Email: sales@toolsrenewed.com

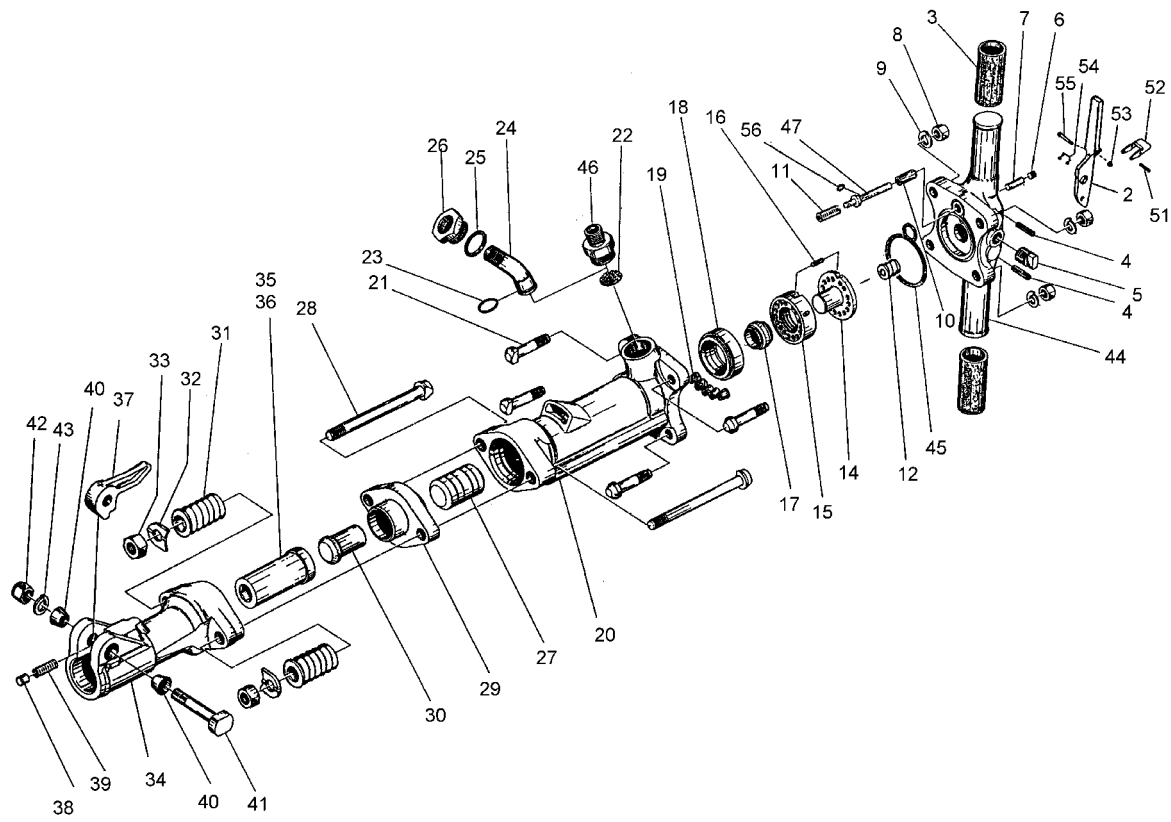

INDEX	PART NUMBER	DESCRIPTION
2	132	LEVER
3	160	GRIP
4	105	PIN
5	108	PLUG
6	111	PLUG
7	112	FELT
8	121	NUT
9	102	LOCKWASHER
10	106	BUSHING
11	107	SPRING
12	114	SPRING
13	113	PLUNGER
14	116	GUIDE
15	117	REAR CHEST
16	115	PIN
17	104	VALVE
18	141	FRONT CHEST
19	1743	PLUG
20	755	CYLINDER
21	239	BOLT
22	123	SCREEN
23	151	O-RING
24	323	SWIVEL
25	1188	O-RING
26	103	NUT
27	118	PISTON

INDEX	PART NUMBER	DESCRIPTION
28	1124	BOLT
29	1382	SEAT
30	1381	TAPPET
31	109	SPRING, SIDE ROD
32	138	LOCKWASHER
33	110	LOCK NUT
34	2996	F. H.—BARE
35	1912	BUSHING 1-1/8" X 6
36	6250	BUSHING 1-1/4" X 6
37	130	RETAINER
38	126	PLUNGER
39	125	SPRING, PLUNGER
40	127	CONE WASHER
41	619	BOLT, RETAINER
42	129	NUT
43	101	LOCKWASHER
44	6280	BACKHEAD, BARE
45	6180	O-RING
46	750	NIPPLE, AIR INLET
47	6808	VALVE, THROTTLE
51	159	PIN
52	156	SAFETY LATCH
53	158	NUT
54	155	SPRING
55	157	BOLT
56	7647	O-RING